



POCKET COLORIMETER™ II
ANALYSIS SYSTEMS

INSTRUCTION MANUAL

Chlorine (Cl₂)

Important Note

This manual is intended for use with the following Pocket Colorimeter™ II instrument:

Chlorine (Cl₂)

Cat. No. 59530-00

Table of Contents

Safety Precautions	1-7
Laboratory Safety	1-7
Use of Hazard Information.....	1-7
Precautionary Labels.....	1-8
Specifications	1-9
Instrument Keys and Display	1-11
Instrument Cap Cord	1-12
Chlorine, Free and Total, LR	1-15
Measuring Hints	1-15
Accuracy Check	1-27
Interferences.....	1-29
Method Performance.....	1-30
Chlorine, Free and Total, HR	1-31
Measuring Hints	1-31
.....	1-38
Accuracy Check	1-39
Interferences.....	1-41

Table of Contents, continued

Method Performance	1-42
Spec[√]™ Secondary Standards for DPD Chlorine	1-43
Using the Spec [√] Standards.....	1-44
Summary of Method	1-45
Replacement Parts	1-46
Instrument Operation	2-3
Key Functions.....	2-3
Menu Selections.....	2-4
Switching Ranges.....	2-4
Setting the Time.....	2-4
Recalling Stored Measurements.....	2-5
Battery Installation.....	2-5
Error Codes	2-7
Error Messages.....	2-7

Table of Contents, continued

Standard Calibration Adjust	2-11
User-Entered Calibration	2-13
Overview	2-13
Calibration Procedure Using Prepared Standards	2-15
Entering a Predetermined Calibration Curve	2-18
Editing a User-entered or Factory Calibration Curve	2-20
Exiting the Calibration Routine.....	2-22
Deleting Calibration Points	2-22
Retrieving the Factory Calibration.....	2-23
Maximum/Minimum Displayed Value.....	2-24
Certification	2-26
How to Order	2-31
Repair Service	2-33
Warranty	2-34

Safety Precautions

Please read this entire manual before unpacking, setting up, or operating this instrument. Pay particular attention to all danger and caution statements. Failure to do so could result in serious injury to the operator or damage to the equipment.

To ensure the protection provided by this equipment is not impaired, do not use or install this equipment in any manner other than that which is specified in this manual.

Laboratory Safety

As part of good laboratory practice, please familiarize yourself with the reagents used in these procedures. Read all product labels and the material safety data sheets (MSDS) before using them. It is always good practice to wear safety glasses when handling chemicals. Follow instructions carefully. Rinse thoroughly if contact occurs. If you have questions about reagents or procedures, please contact the manufacturer or distributor.

Use of Hazard Information

If multiple hazards exist, this manual will use the signal word (Danger, Caution, Note) corresponding to the greatest hazard.

Safety Precautions, continued

DANGER

Indicates a potentially or imminently hazardous situation which, if not avoided, could result in death or serious injury.

CAUTION

Indicates a potentially hazardous situation that may result in minor or moderate injury.

NOTE

Information that requires special emphasis.

Precautionary Labels

Please pay particular attention to labels and tags attached to the instrument. Personal injury or damage to the instrument could occur if not observed.



This symbol, if noted on the instrument, references the instruction manual for operational and/or safety information.

Specifications

Lamp: Light emitting diode (LED)

Detector: Silicon photodiode

Photometric precision: ± 0.0015 Abs

Filter bandwidth: 15 nm

Wavelength: 528 nm

Absorbance range: 0–2.5 Abs

Dimensions: 3.2 x 6.1 x 15.2 cm (1.25 x 2.4 x 6 inches)

Weight: 0.2 kg (0.43 lbs)

Sample cells: 1 cm (10 mL), 25 mm (10 mL)

Operating conditions: 0 to 50 °C (32 to 122 °F); 0 to 90% relative humidity (noncondensing)

Power supply: Four AAA alkaline batteries; approximate life is 2000 tests*

* Backlight usage will decrease battery life.

OPERATION

DANGER

Handling chemical samples, standards, and reagents can be dangerous. Review the necessary Material Safety Data Sheets and become familiar with all safety procedures before handling any chemicals.

DANGER

La manipulation des échantillons chimiques, étalons et réactifs peut être dangereuse. Lire les Fiches de Données de Sécurité des Produits (FDSP) et se familiariser avec toutes les procédures de sécurité avant de manipuler tous les produits chimiques.

PELIGRO

La manipulación de muestras químicas, estándares y reactivos puede ser peligrosa. Revise las fichas de seguridad de materiales y familiarícese con los procedimientos de seguridad antes de manipular productos químicos.

GEFAHR

Das Arbeiten mit chemischen Proben, Standards und Reagenzien ist mit Gefahren verbunden. Es wird dem Benutzer dieser Produkte empfohlen, sich vor der Arbeit mit sicheren Verfahrensweisen und dem richtigen Gebrauch der Chemikalien vertraut zu machen und alle entsprechenden Materialsicherheitsdatenblätter aufmerksam zu lesen.

PERIGO

A manipulação de amostras, padrões e reagentes químicos pode ser perigosa. Reveja a folha dos dados de segurança do material e familiarize-se com todos os procedimentos de segurança antes de manipular quaisquer produtos químicos.

PERICOLO

La manipolazione di campioni, standard e reattivi chimici può essere pericolosa. La preghiamo di prendere conoscenza delle Schede Tecniche necessarie legate alla Sicurezza dei Materiali e di abituarsi con tutte le procedure di sicurezza prima di manipolare ogni prodotto chimico.

Instrument Keys and Display

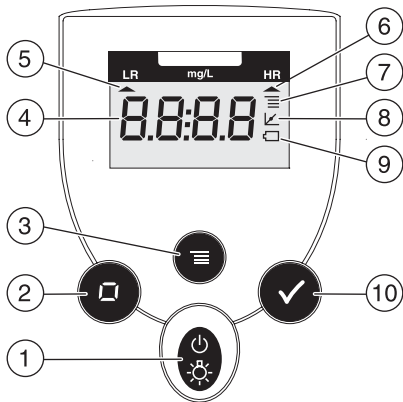

Item	Description
1	POWER/BACKLIGHT Key
2	ZERO/SCROLL Key
3	MENU Key
4	Numeric Display
5	Range Indicator
6	Range Indicator
7	Menu Indicator
8	Calibration Adjusted Indicator
9	Battery Low Indicator
10	READ/ENTER Key

Instrument Cap Cord

The instrument cap for the Pocket Colorimeter™ II doubles as a light shield. Accurate measurements cannot be obtained unless the sample or blank is covered with the cap. Use the instrument cap cord to secure the cap to the body of the colorimeter and prevent loss of the cap. See [Figure 1 on page 1–13](#).

1. Loop the instrument cap cord through the ring on the cap.
2. Remove the battery compartment cover. Press the knotted end of the cord into the hole indicated by the arrow.
3. Slide the cord into the slot on the battery compartment cover. Snap the cover into place.

Instrument Cap Cord, continued

Figure 1 Attaching the Instrument Cap Cord

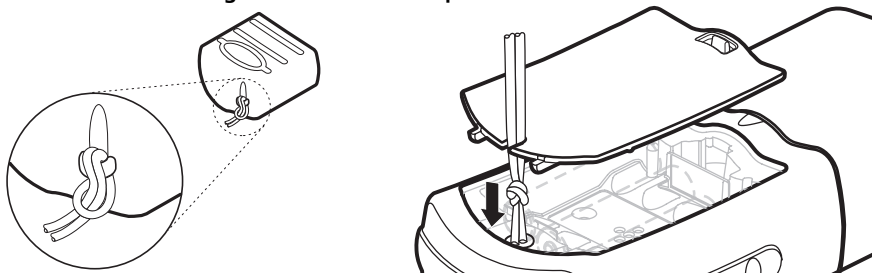

Chlorine, Free and Total, LR (0.02 to 2.00 mg/L Cl₂)

Method 8021 (Free)

For water, treated water, estuary water, and sea water

Method 8167 (Total)

For water, treated water, wastewater, estuary water, and sea water

DPD Method*

USEPA accepted for reporting drinking water analyses**

(free and total chlorine) and wastewater analyses** (total chlorine only)

Measuring Hints

- Analyze samples immediately. Do not use plastic containers to collect samples.
- For best results, dedicate a set of cells to each free chlorine and total chlorine test.

Note: *The Pocket Colorimeter II is designed to measure solutions contained in sample cells. DO NOT dip the meter in the sample or pour the sample directly into the cell holder.*

* Adapted from *Standard Methods for the Examination of Water and Wastewater*.

** Procedure is equivalent to USEPA method 330.5 for wastewater and Standard Method 4500-Cl G for drinking water.

Chlorine, Free and Total, LR, continued

Using Powder Pillows (USEPA accepted for reporting)

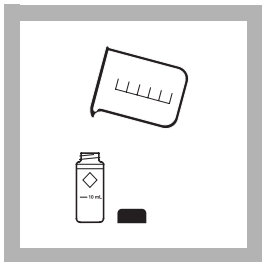

1. Fill a 10-mL cell with sample (the blank). Cap.

Note: *Samples must be analyzed immediately and cannot be preserved for later analysis.*

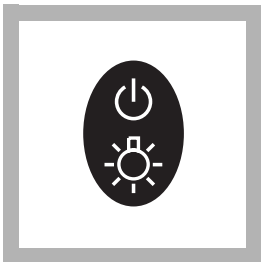

2. Press the **POWER** key to turn the meter on.

The arrow should indicate the low range channel (LR).

Note: See [page 2–4](#) for information on selecting the correct range channel.

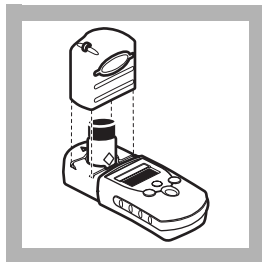

3. Remove the meter cap. Place the blank in the cell holder with the diamond mark facing the keypad. Fit the meter cap over the cell compartment to cover the cell.

Note: *Wipe excess liquid and finger prints off sample cells.*

Chlorine, Free and Total, LR, continued

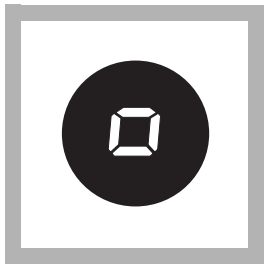

4. Press **ZERO/SCROLL**.

The display will show “- - - -” then “0.00”.

Remove the blank from the cell holder.

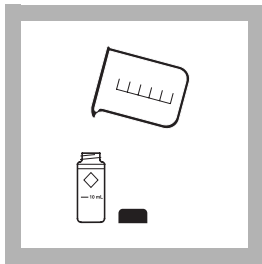

5. Fill a second 10-mL cell to the 10-mL line with sample.

Note: *Do not use the same sample cells for free and total chlorine analysis without thoroughly rinsing the cells with sample between free and total tests.*



6. Add the contents of one DPD Free Chlorine Powder Pillow or one DPD Total Chlorine Powder Pillow to the sample cell (the prepared sample).

Note: *SwifTest™ Dispensers for Free or Total Chlorine can be used in place of powder pillows. See [Using the SwifTest™ Dispenser \(USEPA accepted for reporting\)](#) on page 1–23.*

Chlorine, Free and Total, LR, continued

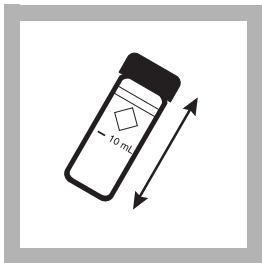

7. Cap and shake gently for 20 seconds.

Note: *Shaking dissipates bubbles that may form in samples with dissolved gases.*

Note: *A pink color will develop if chlorine is present.*

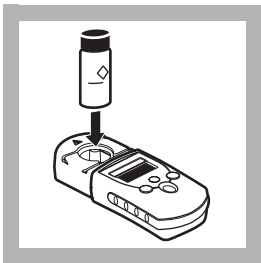

8. For free chlorine, place the prepared sample cell in the cell holder. Cover with the instrument cap and proceed to step 10 within one minute after adding the DPD Free Pillow.

Note: *Accuracy is not affected by undissolved powder.*

Note: *Wipe off sample cells.*

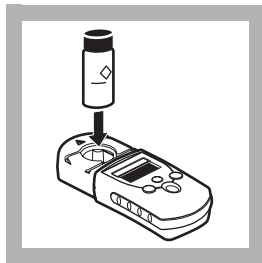

9. For total chlorine, place the prepared sample in the cell holder and cover the cell with the instrument cap. Wait three to six minutes after adding the DPD Total Pillow.

Proceed to step 10.



10. Press **READ/ENTER**.
The instrument will show “- - - -” followed by the results in mg/L chlorine.

Note: *If the sample temporarily turns yellow after reagent addition, or if the display shows overrange (page 2–10) dilute a fresh sample and repeat the test. A slight loss of chlorine may occur because of the dilution. Multiply the result by the appropriate dilution factor.*

Chlorine, Free and Total, LR, continued

Using AccuVac® Ampuls (USEPA accepted for reporting)



1. Fill a 10-mL sample cell with sample (the blank). Cap. Collect at least 40 mL of sample in a 50-mL beaker.

Note: Empty AccuVac Ampuls are available for use as blanks. See [OPTIONAL REAGENTS](#) on page 1–43.

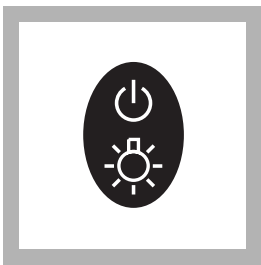

2. Press the **POWER** key to turn on the meter. The arrow in the display should indicate the low range channel (LR).

See [page 2–4](#) for information on selecting the correct range channel.

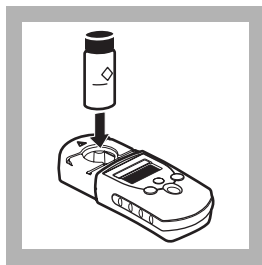

3. Remove the instrument cap. Place the blank in the cell holder, with the diamond mark facing the keypad. Cover the cell with the instrument cap.

Note: Wipe liquid and finger prints off sample cells.

Chlorine, Free and Total, LR, continued

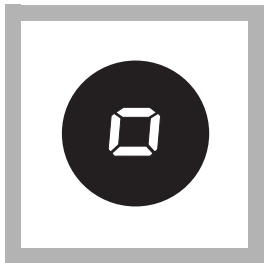

4. Press ZERO/SCROLL.

The display will show “- - - -” then “0.00”.

Remove the blank.

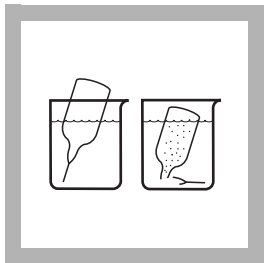

5. Fill a DPD Free Chlorine Reagent AccuVac® Ampul or a DPD Total Chlorine Reagent AccuVac Ampul with sample.

Note: *Keep the tip immersed until the ampule fills completely.*

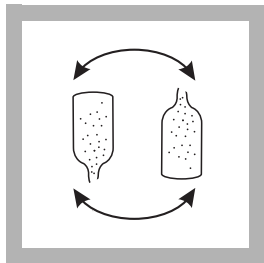

6. Quickly invert the ampule several times to mix. Wipe off any liquid or fingerprints.

Note: *A pink color will form if chlorine is present.*

Note: *Accuracy is not affected by undissolved powder.*

Chlorine, Free and Total, LR, continued

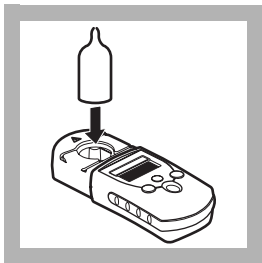

7. For free chlorine, place the prepared sample in the cell holder. Cover the ampule with the instrument cap and proceed to step 9 within one minute after filling the AccuVac Ampul.

Note: *Wipe liquid off the AccuVac Ampul.*

Note: *If the sample temporarily turns yellow after reagent addition, or if the display shows overrange (page 2–10) dilute a fresh sample and repeat the test. A slight loss of chlorine may occur because of the dilution. Multiply the result by the appropriate dilution factor.*

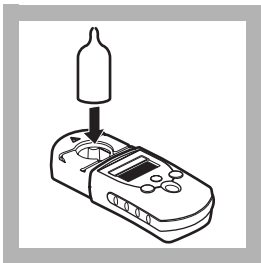

8. For total chlorine, insert the ampule into the cell holder, then cover with the instrument cap. Wait three to six minutes after filling the AccuVac Ampul. Proceed to step 9.

Note: *Wipe liquid off the AccuVac Ampul.*



9. Press **READ/ENTER**. The instrument will show - - - - followed by the results in mg/L chlorine.

Chlorine, Free and Total, LR, continued

Using the SwifTest™ Dispenser (USEPA accepted for reporting)



1. Fill a 10-mL cell with sample (the blank). Cap.

Note: *Samples must be analyzed immediately and cannot be preserved for later analysis.*

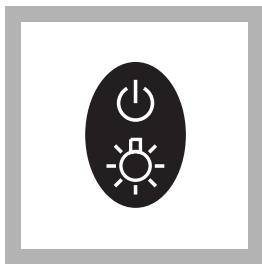

2. Press the **POWER** key to turn the meter on.

The arrow should indicate the low range channel (LR).

Note: *See [page 2–4](#) for information on selecting the correct range channel.*

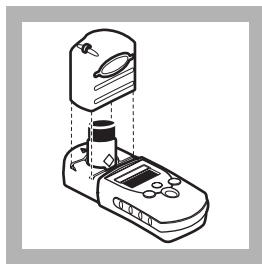

3. Remove the meter cap. Place the blank in the cell holder with the diamond mark facing the keypad. Fit the meter cap over the cell compartment to cover the cell.

Note: *Wipe excess liquid and finger prints off sample cells.*

Chlorine, Free and Total, LR, continued

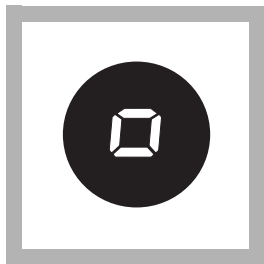

4. Press ZERO/SCROLL.

The display will show “- - - -” then “0.00”.

Remove the blank from the cell holder.

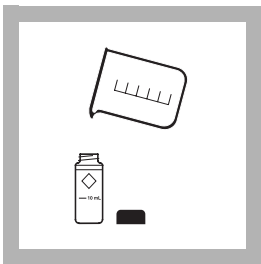

5. Fill a second 10-mL cell to the 10-mL line with sample.

Note: *Do not use the same sample cells for free and total chlorine analysis without thoroughly rinsing the cells with sample between free and total tests.*

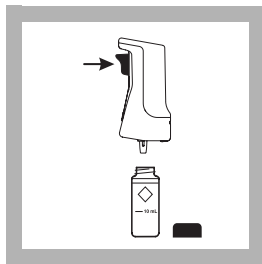

6. Use the SwifTest™ Dispenser to add one dispensation of DPD Free Chlorine reagent or one dispensation of DPD Total Chlorine reagent to the sample cell (the prepared sample).

Chlorine, Free and Total, LR, continued

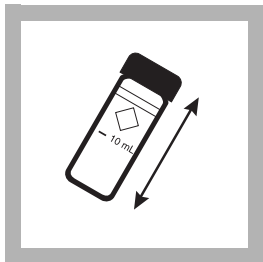

7. Cap and shake gently for 20 seconds.

Note: *Shaking dissipates bubbles that may form in samples with dissolved gases.*

Note: *A pink color will develop if chlorine is present.*

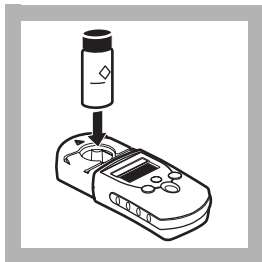

8. For free chlorine, place the prepared sample cell in the cell holder and cover with the instrument cap. Proceed to step 10 within one minute after adding the DPD Free Pillow.

Note: *Accuracy is not affected by undissolved powder.*

Note: *Wipe off sample cells.*

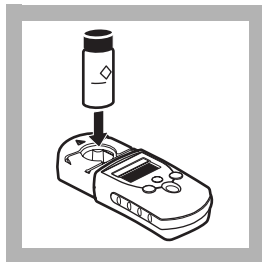

9. For total chlorine, place the prepared sample in the cell holder and cover with the instrument cap. Wait three to six minutes after adding the DPD Total Pillow. Proceed to step 10.

Chlorine, Free and Total, LR, continued



10. Press **READ/ENTER**.

The instrument will show - -
- - followed by the results in
mg/L chlorine.

Note: *If the sample temporarily turns yellow after reagent addition, or if the display shows overrange (page 2–10) dilute a fresh sample and repeat the test. A slight loss of chlorine may occur because of the dilution. Multiply the result by the appropriate dilution factor.*

Accuracy Check

Standard Additions Method

1. Use the ampule breaker to snap the neck off a low range Chlorine Standard Solution Ampule, 20–30 mg/L Cl_2 .
2. Use a TenSette® pipet to add 0.1, 0.2, and 0.3 mL of standard to three 10-mL samples. Swirl gently to mix. (For AccuVac Ampuls, use 0.2, 0.4, and 0.6 mL of standard and a 25-mL sample in a 50-mL beaker.)
3. Analyze a 10-mL aliquot of each sample as described in the procedure. Each 0.1 mL of standard will cause an incremental increase in chlorine. The exact value depends on the concentration of the ampule standard. Check the certificate enclosed with the ampules for the chlorine concentration and calculation of the expected chlorine increase.

Standard Solution Method

Standard solutions for chlorine are difficult and time-consuming to prepare. Errors can occur if attention to detail is not addressed during preparation of the standards. The calibration curve is prepared under rigorous analytical laboratory conditions. Use the factory calibration for most normal testing.

Chlorine, Free and Total, LR, continued

A user calibration or a user-prepared chlorine standard may be required by a regulatory official or agency. Two options are available on the Pocket Colorimeter II to meet this requirement.

A chlorine standard may be prepared and used to validate the calibration curve using the Standard Calibration Adjust feature (see [page 2–11](#) for more information). The concentration of the prepared standard must be determined with an alternate instrument such as a spectrophotometer, colorimeter, or by using an alternate method such as amperometric titration. The concentration of the chlorine standard for the LR procedure must be between 0.50 and 1.50 mg/L chlorine.

In addition, a user-generated calibration curve can be programmed into the Pocket Colorimeter™ II. See [User-Entered Calibration on page 2–13](#) for more information.

Chlorine, Free and Total, LR, continued

Interferences

Interfering Substance	Interference Levels and Treatments
Acidity	Greater than 150 mg/L CaCO_3 . May not develop full color or color may fade instantly. Neutralize to pH 6–7 with 1 N Sodium Hydroxide. Determine amount to be added on a separate 10-mL sample, then add the same amount to the sample being tested. Correct for the additional volume.
Alkalinity	Greater than 250 mg/L CaCO_3 . May not develop full color or color may fade instantly. Neutralize to pH 6–7 with 1 N Sulfuric Acid. Determine amount to be added on a separate 10-mL sample, then add the same amount to the sample being tested. Correct for the additional volume.
Bromine, Br_2	Interferes at all levels
Hardness	No effect at less than 1,000 mg/L as CaCO_3
Iodine, I_2	Interferes at all levels

Chlorine, Free and Total, LR, continued

Interfering Substance	Interference Levels and Treatments
Manganese, Oxidized (Mn^{4+} , Mn^{7+}) or Chromium, Oxidized (Cr^{6+})	<ol style="list-style-type: none">1. Adjust sample pH to 6–7.2. Add 3 drops Potassium Iodide (30-g/L) (Cat. No. 343-32) to a 10-mL sample.3. Mix and wait one minute.4. Add 3 drops Sodium Arsenite (5-g/L) (Cat. No. 1047-32) and mix.5. Analyze 10 mL of the treated sample as described in the procedure.6. Subtract the result from this test from the original analysis to obtain the correct chlorine concentration.
Monochloramine, LR method	Causes a gradual drift to higher readings. When read within 1 minute after reagent addition, 3 mg/L monochloramine causes less than a 0.1 mg/L increase in the reading.
Ozone	Interferes at all levels.

Method Performance

Estimated Detection Limit (EDL) = 0.02 mg/L

Typical precision (95% confidence interval) = 1.00 ± 0.05 mg/L

Chlorine, Free and Total, HR (0.1 to 8.0 mg/L Cl₂)

For water, treated water, estuary water, and seawater (Free Chlorine)

For water, treated waters, wastewater, estuary water, and seawater
(Total Chlorine)

DPD Method*

USEPA accepted for reporting drinking water analyses (free and total chlorine) and wastewater analyses (total chlorine).

Measuring Hints

- If the chlorine concentration is typically less than 2 mg/L, use the low range procedure.
- Analyze samples immediately. Do not use plastic containers to collect samples. For best results, dedicate a set of sample cells to each test (free and total).
- If the sample temporarily turns yellow after reagent addition or shows overrange ([page 2–10](#)), dilute a fresh sample and repeat the test. A slight loss of chlorine may occur. Multiply the result by the dilution factor.

* Adapted from *Standard Methods for the Examination of Water and Wastewater*.

Chlorine, Free and Total, HR, continued

- High range free chlorine determinations are subject to variable levels of interferences from monochloramine. See Interferences on page 1–41.

Note: *The Pocket Colorimeter II is designed to measure solutions contained in sample cells. **DO NOT** dip the meter in the sample or pour the sample directly into the cell holder.*

Using Powder Pillows

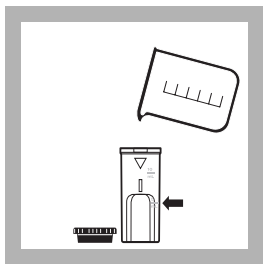

1. Fill a 1-cm/10-mL cell with sample (the blank). Cap.

Note: Samples must be analyzed immediately and cannot be preserved for later analysis.

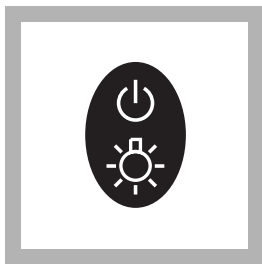

2. Press the **POWER** key to turn the meter on.

The arrow should indicate the high range channel (HR).

Note: See [page 2–4](#) for information on selecting the correct range channel.



3. Remove the meter cap. Place the blank into the cell holder, with the diamond mark facing the back of the cell holder. Cover the cell with the cap.

Note: Wipe liquid off sample cells.

Chlorine, Free and Total, HR, continued



4. Press: ZERO/SCROLL

The display will show “- - - -” followed by “0.0”.

Remove the blank.

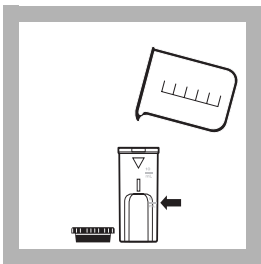

5. Fill another 1-cm/10-mL sample cell to the 5-mL line with sample. Cap.

Note: Do not use the same sample cells for free and total chlorine without thoroughly rinsing the cells between the free and total tests.

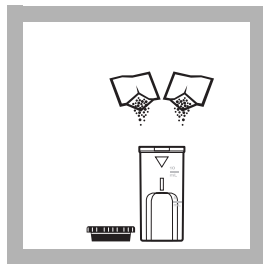

6. Add the contents of two DPD Free Chlorine or two DPD Total Chlorine Powder Pillows to the sample cell (the prepared sample). Cap the cell and shake gently for 20 seconds.

Note: Gentle shaking dissipates bubbles which may form in samples containing dissolved gases.

Chlorine, Free and Total, HR, continued



7. For free chlorine, place the prepared sample cell in the cell holder and cover with the instrument cap within **one** minute after adding the DPD Free Pillow.

Proceed immediately to step 9.

Note: *The SwifTest™ Dispenser can be used in place of the powder pillow (see page 1—36).*



8. For total chlorine, place the prepared sample in the cell holder and cover with the instrument cap. Wait **three to six** minutes after adding the DPD Total Pillows. Proceed to step 9.

Note: *Wipe off sample cells.*

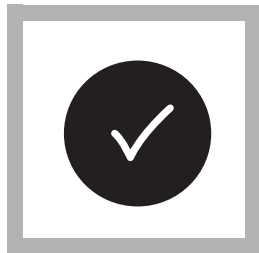

9. Press **READ/ENTER**. The instrument will show “- - - -” followed by the results in mg/L chlorine (Cl₂).

Chlorine, Free and Total, HR, continued

Using the SwifTest™ Dispenser

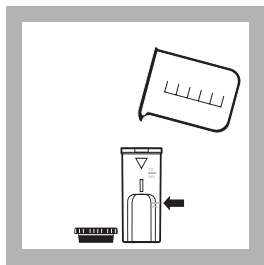

1. Fill a 1-cm/10-mL cell with sample (the blank). Cap.

Note: Samples must be analyzed immediately and cannot be preserved for later analysis.

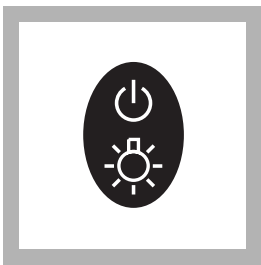

2. Press the **POWER** key to turn the meter on.

The arrow should indicate the high range channel (HR).

Note: See [page 2–4](#) for information on selecting the correct range channel.



3. Remove the meter cap. Place the blank into the cell holder, with the diamond mark facing the back of the cell holder. Cover the cell with the cap.

Note: Wipe liquid off sample cells.

Chlorine, Free and Total, HR, continued

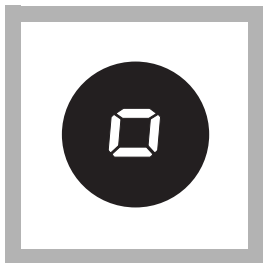

4. Press: ZERO/SCROLL

The display will show “- - - -” followed by “0.0”.

Remove the blank.

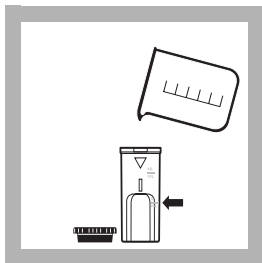

5. Fill another 1-cm/10-mL sample cell to the 5-mL line with sample. Cap.

Note: Do not use the same sample cells for free and total chlorine without thoroughly rinsing the cells between the free and total tests.

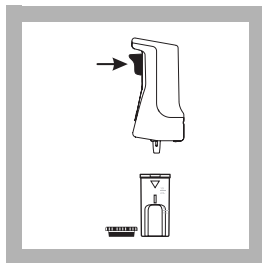

6. Use the SwifTest™ Dispenser to add two dispensations of DPD Free Chlorine reagent or DPD Total Chlorine reagent to the sample cell (the prepared sample). Cap the cell and shake gently for 20 seconds.

Note: Gentle shaking dissipates bubbles.

Chlorine, Free and Total, HR, continued

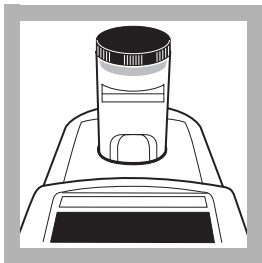

7. For free chlorine, place the prepared sample cell in the cell holder and cover with the instrument cap within **one** minute after adding the DPD Free Pillow.

Proceed immediately to *step 9*.

Note: *Wipe liquid off sample cells.*

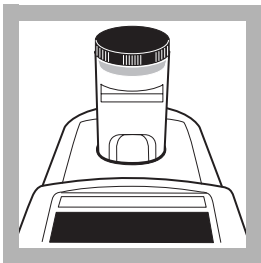

8. For total chlorine, place the prepared sample in the cell holder and cover with the instrument cap. Wait **three to six** minutes after adding the DPD Total Pillows. Proceed to *step 9*.

Note: *Wipe liquid off sample cells.*



9. Press **READ/ENTER**.

The instrument will show “- - -” followed by the results in mg/L chlorine (Cl₂).

Accuracy Check

Standard Additions Method

- a. Use the ampule breaker to snap the neck off a high range Chlorine Standard Solution Ampule, 50–70 mg/L Cl_2 .
- b. Use a TenSette® pipet to add 0.1, 0.2, and 0.3 mL of standard to three 5-mL samples. Swirl gently to mix.
- c. Analyze each sample as described in the procedure. Each 0.1 mL of standard will cause an incremental increase in chlorine. The exact value depends on the concentration of the ampule standard. Check the certificate enclosed with the ampules for calculation of the expected increase in the chlorine concentration.

Standard Solution Method

Standard solutions for chlorine are difficult and time-consuming to prepare. Errors can occur if attention to detail is not addressed during preparation of the standards. The calibration curve is prepared under rigorous analytical laboratory conditions. Use the factory calibration for most normal testing.

Chlorine, Free and Total, HR, continued

A user calibration or a user-prepared chlorine standard may be required by a regulatory official or agency. Two options are available on the Pocket Colorimeter™ II to meet this requirement.

A chlorine standard may be prepared and used to validate the calibration curve using the Standard Calibration Adjust feature (see [page 2–11](#) for more information). The concentration of the prepared standard must be determined with an alternate instrument such as a spectrophotometer, colorimeter, or by using an alternate method such as amperometric titration. The concentration of the chlorine standard for the HR procedure must be between 4.5 and 7.0 mg/L chlorine.

In addition, a user-generated calibration curve can be programmed into the Pocket Colorimeter™ II. See [User-Entered Calibration on page 2–13](#) for more information.

Interferences

Interfering Substance	Interference Levels and Treatments				
Monochloramine	For conventional free chlorine disinfection (beyond the breakpoint), monochloramine concentrations are very low. If monochloramine is present in the sample, its interference in the free chlorine test varies with the temperature, the relative amount of monochloramine to free ammonia, and the time required to do the analysis. Approximate interference levels of monochloramine in the free chlorine test are listed below (as mg/L Cl ₂).				
	NH ₂ Cl	Sample Temperature °C (°F)			
	(as Cl ₂)	5 (40)	10 (50)	20 (68)	30 (83)
	1.2	0.2	0.2	0.3	0.3
	2.5	0.4	0.5	0.6	0.6
3.5	0.5	0.6	0.7	0.8	

See additional [Interferences on page 1–29](#).

Chlorine, Free and Total, HR, continued

Method Performance

Estimated Detection Limit (EDL) = 0.1 mg/L

Typical precision (95% confidence interval) = 5.0 ± 0.2 mg/L

Specv™ Secondary Standards for DPD Chlorine

Note: *Due to improvements in the optical system of the Pocket Colorimeter™ II, the tolerance ranges and values on the Certificate of Analysis of previously purchased Spec v standards may no longer be valid. Obtain a new set of standards, or use the Pocket Colorimeter II to assign new values to existing standards.*

The DPD Chlorine Specv Secondary Standards are available to quickly check the repeatability of the Pocket Colorimeter™ II instrument (see OPTIONAL REAGENTS on page 1–47).

After initial measurements for the Specv standards are collected in the low range (LR) channel, the standards can be re-checked as often as desired to ensure the instrument is working consistently.

The standards do not ensure reagent quality nor do they ensure the accuracy of the test results. Analysis of real standard solutions using the kit reagents is required to verify the accuracy of the entire Pocket Colorimeter system. The Specv Standards should *NEVER* be used to calibrate the instrument. The certificate of analysis lists the expected value and tolerance for each Specv Standard.

Note: *Before proceeding, make sure the instrument is in the low (LR) range channel. See Switching Ranges on page 2–4.*

Using the Spec \checkmark Standards

1. Place the colorless Spec \checkmark blank into the cell holder with the alignment mark facing the keypad. Tightly cover the cell with the instrument cap.
2. Press **ZERO**. The display will show “0.00”.
3. Place the STD 1 cell into the cell holder. Tightly cover the cell with the instrument cap.
4. Press **READ/ENTER**. Record the concentration measurement.
5. Repeat steps 3 and 4 with cells labeled STD 2 and STD 3.
6. Compare these measurements with previous measurements to verify the instrument is performing consistently. (If these are the first measurements, record them for comparison with later measurements.)

Note: *If the instrument is user-calibrated, initial standard measurements of the Spec \checkmark Standards will need to be performed again for the user calibration.*

Summary of Method

Chlorine can be present in water as free chlorine and as combined chlorine. Both forms can coexist in the same solution and can be determined together as total chlorine. Free chlorine is present as hypochlorous acid or hypochlorite ion.

Combined chlorine represents a combination of chlorine-containing compounds including but not limited to monochloramine, dichloramine, nitrogen trichloride, and other chloro derivatives. The combined chlorine oxidizes triiodide ion (I_3^-) to iodine (I_2). The iodine and free chlorine reacts with DPD

(N,N-diethyl-p-phenylenediamine) to form a red solution. The color intensity is proportional to the total chlorine concentration. To determine the concentration of combined chlorine, run a free chlorine test and a total chlorine test. Subtract the results of the free chlorine test from the total chlorine test to obtain the combined chlorine concentration.

The range of analysis using the DPD method for chlorine can be extended by adding more indicator in proportion to sample volume. For example, two powder pillows of DPD Chlorine Reagent are added to a 5-mL sample portion to extend the range of analysis.

Replacement Parts

REQUIRED REAGENTS

Description	Unit	Cat. No.
-------------	------	----------

Free Chlorine Tests

DPD Free Chlorine Reagent Powder Pillows	100/pkg21055-69
--	---------	---------------

or

DPD Free Chlorine Reagent AccuVac® Ampuls		
---	--	--

(low range test only)	25/pkg 25020-25
-----------------------------	--------	---------------

SwifTest™ DPD Free Chlorine Reagent with dispenser	250* tests	... 28023-00
--	------------	--------------

Total Chlorine Tests

DPD Total Chlorine Reagent Powder Pillows.....	100/pkg21056-69
--	---------	---------------

or

DPD Total Chlorine Reagent AccuVac® Ampuls		
--	--	--

(low range test only)	25/pkg 25030-25
-----------------------------	--------	---------------

SwifTest™ DPD Total Chlorine Reagent with dispenser.....	250* tests	... 28024-00
--	------------	--------------

REQUIRED APPARATUS (AccuVac® Ampuls)

Beaker, 50 mL	each 500-41H
---------------------	------	---------------

* 125 tests when performing the high range test

Replacement Parts, continued

OPTIONAL REAGENTS

Description	Unit	Cat. No.
Chlorine Standard Solution, 25–30 mg/L, 2-mL	20/pkg	26300-20
Chlorine Standard Solution, 50–75 mg/L, 2-mL	20/pkg	14268-20
Chlorine Standards, secondary, SpecV TM , 0.0, 0.2, 0.8 and 1.5 mg/L	4/pkg	26353-00
Empty AccuVac [®] Ampuls (for reading blanks)	25/pkg	26779-25
Potassium Iodide Solution, 30 g/L.....	100 mL MDB*	343-32
SpecV TM Secondary Standards, Chlorine	each	26353-00
Sodium Arsenite Solution, 5 g/L.....	100 mL MDB	1047-32
Sodium Hydroxide Standard Solution, 1 N.....	100 mL MDB	1045-32
Sulfuric Acid Standard Solution, 1 N.....	100 mL MDB	1270-32
SwifTest TM DPD Free Reagent Replacement Vial	250** tests	21055-60
SwifTest TM DPD Total Reagent Replacement Vial.....	250** tests	21056-60
Water, deionized.....	4 L	272-56

* Marked Dropper Bottle

** 125 tests when performing the high range test

Replacement Parts, continued

OPTIONAL APPARATUS

Description	Unit	Cat. No.
AccuVac [®] Snapper Kit.....	each	24052-00
Ampule Breaker Kit.....	each	24846-00
Batteries, AAA, alkaline	4/pkg	46743-00
Caps for 10-mL sample cells	12/pkg	24018-12
Cylinder, graduated, 25 mL, glass	each	508-40
Cylinder, graduated, 100 mL, glass	each	508-42
sensio <i>n</i> [™] I Basic Portable pH Meter, with electrode	each	51700-10
Pipet, TenSette [®] , 0.1 to 1.0 mL	each	19700-01
Pipet Tips, For 19700-01 TenSette [®] Pipet	50/pkg	21856-96
Sample Cells, 10-mL with screw caps.....	6/pkg	24276-06

REPLACEMENT PARTS

Cap for 1-cm/10 mL sample cell	each	52626-00
Instrument Cap/light shield.....	each	59548-00
Instrument Manual.....	each	59570-88
Sample Cells, 1-cm/10-mL	2/pkg	48643-02







Section 2

Instrument Manual

Instrument Operation

Key Functions

Key	Description	Function
	POWER Key	On/Off/Backlight To turn on the backlight, turn on the instrument, then press and hold the power key until the backlight turns on. Press and hold again to turn off the backlight. This key functions the same in all instrument modes and ranges.
	ZERO/SCROLL Key	In measurement mode, sets the instrument to zero. In menu mode, scrolls through menu options. Also scrolls numbers when entering or editing a value.
	READ/ENTER Key	In measurement mode, initiates sample measurement. In menu mode, selects a menu option. When entering numbers, moves one space to the right and executes the function when the entry is complete.
	MENU Key	Enter/Exit the menu mode Press and hold for approximately 5 seconds to enter user-entered method mode.

Instrument Operation, continued

Menu Selections

Press the **MENU** key to access the menu selections.

Switching Ranges

1. Press the **MENU** key. The display will show “SEL”. A flashing arrow indicates the current range.
2. Press the **READ/ENTER** key to toggle between ranges.
3. Press **MENU** again to accept and exit back to the measurement screen.

Setting the Time

1. Press the **MENU** key, then press the **ZERO/SCROLL** key until the display shows a time in the “00:00” format.
2. Press **READ/ENTER**. The digit to be edited will flash.
3. Use the **ZERO/SCROLL** key to change the entry, then press **READ/ENTER** to accept and advance to the next digit. The time is entered in 24-hour format.

Recalling Stored Measurements

1. Press the **MENU** key, then press the **ZERO/SCROLL** key until the display shows RCL. The instrument automatically stores the last 10 measurements.
2. In RCL, press **READ/ENTER** to recall the stored measurements, beginning with the most recent measurement taken. The meter stores the measurement number as 01 (most recent) through 10 (oldest), the time the measurement was taken, and the measurement value. The **ZERO/SCROLL** key allows for selection of a specific measurement by number. The **READ/ENTER** key scrolls through all stored data points.



Battery Installation

Figure 1 on page 2–6 provides an exploded view of battery installation.

1. Unhook the latch and remove the battery compartment cover. The polarities are shown on the battery holder.
2. Place the four batteries provided with the instrument in the holder as indicated and replace the battery compartment cover. The display will show the software version number (e.g., “P 1.6”) after correct battery installation.

Instrument Operation, continued

When replacing discharged batteries, always replace the complete set of four alkaline batteries. Rechargeable batteries are not recommended and cannot be recharged in the instrument.

Note: *The Low Battery icon will appear on the display when the batteries have 10% battery life remaining. The battery icon will flash when the batteries are too low to complete measurements. See [Instrument Keys and Display on page 1–11](#).*

Figure 1 **Battery Installation**

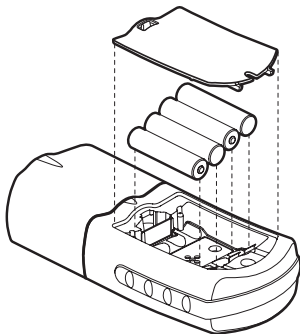

Error Codes

When the instrument cannot perform the function initiated by the operator, an error message will appear in the display. Refer to the appropriate message information below to determine what the problem is and how it can be corrected. Resolve error messages in the order that they appear on the display. Service Centers are listed in [page 2–33](#).

Error Messages

1. E-0 No Zero (User mode)

Error occurs when trying to read a standard in the user calibration mode before setting the meter to zero.

- Zero the instrument on an appropriate blank.

2. E-1 Ambient Light Error

There is too much light present to take a valid measurement.

- Verify instrument cap is correctly seated.
- Contact a Service Center ([page 2–33](#)).

Error Codes, continued

3. E-2 LED Error

The LED (light source) is out of regulation.

- Replace batteries.
- Verify LED lights up (inside the cell holder) when the **READ/ENTER** or **ZERO/SCROLL** key is pressed.
- Contact a Service Center ([page 2–33](#)).

Note: *When an E-1 or E-2 error occurs on a measurement, the display will show “_._” (The decimal place is determined by the chemistry.) If the E-1 or E-2 error occurs while zeroing the meter, the meter will require the user to re-zero.*

4. E-3 Standard Adjust Error

The value obtained on the prepared standard exceeds the adjustment limits allowed for the standard concentration, or the concentration of the standard is outside the concentration range allowed for standard calibration adjust.

- Prepare the standard and rerun according to the procedure.
- Prepare a standard at or near the recommended concentrations given in the procedure.
- Verify that the concentration of the standard has been entered correctly.

- Contact a Service Center ([page 2–33](#)).

5. E-6 Abs Error (User mode)

Indicates that the absorbance value is invalid, or indicates an attempt to make a curve with less than two points.

- Enter or measure the absorbance value again.
- Contact a Service Center ([page 2–33](#)).

6. E-7 Standard Value Error (User mode)

Standard concentration is equal to another standard concentration that is already entered.

- Enter the correct standard concentration.
- Contact a Service Center ([page 2–33](#)).

7. E-9 Flash Error

The meter is unable to save data.

- Contact a Service Center ([page 2–33](#)).

Error Codes, continued

8. Underrange—flashing number below stated test range

- Verify instrument cap is correctly seated.
- Check zero by measuring a blank. If error recurs, re-zero the instrument.
- Contact a Service Center ([page 2–33](#)).

Note: See *Maximum/Minimum Displayed Value on page 2–24* for more information.

9. Overage—flashing number above stated test range

Note: *Flashing value will be 10% over the upper test limit.*

- Check for light blockage.
- Dilute and retest sample.

Note: See *Maximum/Minimum Displayed Value on page 2–24* for more information.

Standard Calibration Adjust

The Pocket Colorimeter™ II instrument is factory-calibrated and ready for use without user calibration. Use of the factory calibration is recommended unless the user is required to generate a calibration. The Standard Calibration Adjust can be used to meet regulatory requirements.

This feature allows the factory default calibration curve to be adjusted with a known standard. Use the standard described in the procedure.

1. Place a blank in the meter (in measurement mode). Press **ZERO/SCROLL**.
2. Place the reacted standard in the meter. Press **READ/ENTER**.
3. Press **MENU**, then press the **ZERO/SCROLL** key until the display shows “SCA”.
4. Press **READ/ENTER** to display the standard calibration adjust value.
5. Press **READ/ENTER** to adjust the curve to the displayed value. The meter will return to the measurement mode and the “calibration adjusted” icon will appear in the display window.

If an alternate concentration is used, or if a standard concentration is not given:

6. Repeat steps 1–4.

Standard Calibration Adjust, continued

7. Press **ZERO/SCROLL** to access the Edit function, then press **READ/ENTER** to begin editing. The digit to be edited will flash. Use the **ZERO/SCROLL** key to change the entry, then press **READ/ENTER** to accept and advance to the next digit.

When the last digit is entered, press **READ/ENTER** and the meter will adjust the curve to the value entered. The meter will return to measurement mode and the “calibration adjusted” icon will appear in the display window.

To turn off Standard Calibration Adjust:

1. Press **MENU**.
2. Press **ZERO/SCROLL** until “SCA” appears in the display.
3. Press **READ/ENTER**, then press **ZERO/SCROLL** until “Off” appears in the display.
4. Press **READ/ENTER** to turn off SCA.

Note: *Perform another standard calibration adjust to turn SCA “on” again.*

Note: *For meters with factory-calibrated ranges or methods, Standard Calibration Adjust (SCA) will be disabled when a user-entered method is programmed into the meter. To turn SCA back on, restore the meter to factory default calibration. See Retrieving the Factory Calibration on page 2–23.*

User-Entered Calibration

Overview

The Pocket Colorimeter™ II will accept a user-prepared calibration curve. The curve can extend from 0 to 2.5 absorbance. A user-prepared calibration curve may be entered into any channel that does not contain a factory-programmed curve. These channels are labeled “abs” on instruments having a single factory calibration or are labeled “1” and “2” on the uncalibrated single wavelength instruments. Any chemistry that can be run at the instrument wavelength may be user-entered in these channels.

Using prepared standard solutions that cover the range of interest, the meter generates a calibration curve by calculating the straight-line segments between each standard entered. A calibration curve may be entered using the keypad. Factory-entered calibration curves may also be recalculated or adjusted using the same procedure.

To enter the user-entered calibration mode, press the **MENU** key and hold it down until the display shows “USER” (about 5 seconds), followed by “CAL”. Press **ZERO/SCROLL** to scroll through the options.

User-Entered Calibration, continued

- CAL—Used to enter and edit standard values and measure absorbance values, or review the existing calibration.
- Edit—Used to enter and edit standard values and absorbance values with the keypad or review the existing calibration. Used to enter a predetermined calibration curve.
- dFL—Used to return the instrument back to the default factory calibration. User-entered calibrations are stored upon exit from the calibration or edit modes.

Note: *To return to factory settings, following the instructions in [Retrieving the Factory Calibration on page 2–23](#).*

If the instrument is shut off or loses power during data entry, all edits will be lost. Automatic shut-off in user-entered calibration entry mode is 60 minutes.

"CAL" and "Edit" Submenus

In CAL mode, standard values are entered and absorbance values are measured. In Edit mode, standard and absorbance values are entered.

- To select CAL from the User menu, press **READ/ENTER**.
- To select Edit from the User menu, press **ZERO/SCROLL** and **READ/ENTER**.

- Once in the CAL or Edit option, press the **READ/ENTER** key to navigate through each option.

Note: Press **ZERO/SCROLL** to quickly scroll through each option.

Calibration Procedure Using Prepared Standards

Note: *Deionized water or a reagent blank can be used to zero during the calibration procedure. Calibrations generated with deionized water as the zero will give less accurate results if the reagent blank is significantly more turbid or colored than deionized water. Use the deionized water or the reagent blank as the zero concentration point (SO) in the following calibration procedure.*

1. Turn on the instrument and select the range to be calibrated. An arrow at the top of the display will point to the selected range. To change ranges, press the **MENU** key, then use the **READ/ENTER** key to toggle between ranges 1 and 2. Press **MENU** again to return to measurement mode.
2. Follow the procedure for the chemical method to be calibrated. Prepare a reagent blank (if needed) and a standard solution. Allow the color to develop fully.

User-Entered Calibration, continued

3. Insert the reagent blank or deionized water into the meter and cover with the cap. Press the **ZERO/SCROLL** key. The meter will display “- - -”, followed by “0.000”. This initializes (zeroes) the meter.
4. Press the **MENU** key and hold it down until the display shows “USER”, followed by “CAL”. Press **READ/ENTER** to enter the calibration mode.
5. In factory-calibrated meters, S0 will appear in the display.
Note: *When recalibrating a factory-calibrated meter or range, RES (resolution) cannot be changed.*
6. In uncalibrated meters or meters with ranges labeled Abs, “RES” will appear. Press **ZERO/SCROLL** to review the current resolution (decimal placement). Press **ZERO/SCROLL** again to accept the current resolution. To change the resolution, press **READ/ENTER**, then **ZERO/SCROLL** to change the resolution. Press **READ/ENTER** to accept the new resolution. “S0” will appear on the display.
7. Press the **READ/ENTER** key again, then enter the blank value.
Note: *Press the READ/ENTER key to move from digit to digit. Use the ZERO/SCROLL key to change the number.*
8. After completing entry of the blank value, press the **READ/ENTER** key. The display will show “A0”.

User-Entered Calibration, continued

9. Insert the reagent blank or deionized water into the cell holder. Cover the blank with the instrument cap.
10. Press the **READ/ENTER** key. The meter will measure and display the absorbance value for “S0”.
11. Remove the sample blank. Press the **ZERO/SCROLL** key. “S1” will appear. Press the **READ/ENTER** key, then enter the first standard value.

Note: *Press the **READ/ENTER** key to move from digit to digit. Use the **ZERO/SCROLL** key to change the number.*

12. After completing entry of the first standard value, press the **READ/ENTER** key. The display will show “A1”.
13. Insert the first reacted standard solution into the cell holder. Cover the prepared standard with the instrument cap.
14. Press the **READ/ENTER** key. The meter will measure and display the absorbance value for S1.
15. The calibration is complete with two points. If additional standards are required, press **ZERO/SCROLL** until “Add” appears on the display. Repeat steps 11–14 to enter additional standards.

User-Entered Calibration, continued

16. Press the **MENU** key twice to exit and accept the changes. The instrument will use this calibration to determine the displayed concentration of future sample measurements.

Entering a Predetermined Calibration Curve

Note: *Entering a predetermined calibration curve requires at least two data pairs. Each data pair requires a concentration value and the absorbance value for the given concentration. Up to 10 data pairs may be entered. This procedure uses the Edit mode.*

1. Turn on the instrument and select the range to be calibrated. An arrow at the top of the display will point to the selected range. To change ranges, press the **MENU** key, then use the **READ/ENTER** key to toggle between ranges 1 and 2. Press **MENU** again to return to measurement mode.
2. Press the **MENU** key and hold it down until the display shows “USER”, followed by “CAL”. Press **ZERO/SCROLL** to scroll to EDIT. Press **READ/ENTER**.
3. In uncalibrated meters or in Abs range, “RES” will appear. Press **ZERO/SCROLL**. To change the resolution (decimal placement), press **READ/ENTER**. Press **ZERO/SCROLL** to select the new resolution, then press **READ/ENTER** to accept. “S0” will appear on the display.

User-Entered Calibration, continued

4. Enter the concentration value and absorbance value of the first data pair (S0, A0).
5. To enter the S0 value, press **READ/ENTER**. Use the **ZERO/SCROLL** key to select the numerical value, then press the **READ/ENTER** key to accept the entry and advance to the next decimal place. Repeat this sequence until the S0 concentration value is entered.
6. After editing the S0 value, press **READ/ENTER** to accept. "A0" will appear on the display.
7. To enter the absorbance value for S0, press the **READ/ENTER** key to go to entry mode. Use the **ZERO/SCROLL** key to select the numerical value, then press the **READ/ENTER** key to accept the entry and advance to the next decimal place. Repeat this sequence until the absorbance value for S0 is entered.
8. After entering A0, press **READ/ENTER** to accept. "S1" will appear on the display.
9. Repeat steps 5 through 8 for each standard value and absorbance value pair in the calibration curve

Note: *After A1 is entered, Add will appear in the display. If additional data pairs are to be entered, press **READ/ENTER** and continue with step 9.*

User-Entered Calibration, continued

10. When all the calibration data has been entered, press **MENU** twice to return to the measurement mode.

Editing a User-entered or Factory Calibration Curve

1. Press the **MENU** key and hold it down until the display shows “USER”, followed by “CAL”. Press **ZERO/SCROLL** until EDIT appears.
2. Press the **READ/ENTER** key to enter Edit mode. In factory-calibrated meters, “S0” will appear in the display.

Note: *When editing a factory-calibrated meter or range, RES (resolution) cannot be changed.*

Note: *When RES or S0 appears in the display, press **ZERO/SCROLL** to quickly scroll to the data to be edited.*

3. In uncalibrated meters or in Abs range, “RES” will appear. Press **ZERO/SCROLL** to review the current resolution. Press **ZERO/SCROLL** again to accept the displayed resolution. To change the resolution (decimal placement), press **READ/ENTER**. Press **ZERO/SCROLL** to select the new resolution, then press **READ/ENTER** to accept. “S0” will appear on the display.

User-Entered Calibration, continued

4. Press **READ/ENTER**. The current concentration value for S0 will appear on the display.
5. To edit the S0 value, press **READ/ENTER**. Use the **ZERO/SCROLL** key to select the numerical value, then press the **READ/ENTER** key to accept the entry and advance to the next decimal place. Repeat this sequence until the S0 concentration value is entered.
6. After editing the S0 value, press **READ/ENTER** to accept. "A0" will appear on the display.
7. To edit the absorbance value for S0, press the **READ/ENTER** key to go to entry mode. Use the **ZERO/SCROLL** key to select the numerical value, then press the **READ/ENTER** key to accept the entry and advance to the next decimal place. Repeat this sequence until the absorbance value for S0 is entered.
8. After editing A0, press **READ/ENTER** to accept. "S1" will appear on the display.
9. Repeat steps 4 through 8 for each standard value and absorbance value pair in the calibration curve.
10. When all calibration data has been reviewed or edited, "ADD" will appear in the display.

User-Entered Calibration, continued

11. Press **READ/ENTER** to add more calibration points, or press **MENU** twice to return to the measurement mode.

Note: *When a factory calibration curve has been edited, the "calibration adjust" icon will appear in the display.*

Exiting the Calibration Routine

Exit the calibration routine by pressing the **MENU** key to step back through to measurement mode. The instrument uses the last completed user-entered calibration or the factory calibration if no user-entered calibration has been completed.

Deleting Calibration Points

1. Select the range containing user-entered calibration points. See [Switching Ranges on page 2–4](#).
2. Press and hold the **MENU** key until "USER", then "CAL" appears. Press **READ/ENTER**.

Note: *Calibration points can also be deleted in Edit mode.*

3. Press **ZERO/SCROLL** to select the point to delete (e.g., S0 or S1 or S2). Press **READ/ENTER**.

User-Entered Calibration, continued

4. The left digit will flash. Press **ZERO/SCROLL** until “dEL” appears. (“dEL” will appear after the numeral 9.)
5. Press **READ/ENTER** to delete. Repeat for all points to be deleted.
Note: *The minimum number of valid points is two. For example, if five points have been entered, three can be deleted using this feature.*
6. Press **MENU** to return to the measurement mode.

Retrieving the Factory Calibration

1. Select the range to restore factory default calibration. See [Switching Ranges on page 2–4](#).
2. Press and hold the **MENU** key until “USER”, then “CAL” appears.
3. Press the **ZERO/SCROLL** key to find dFL.
4. Press the **READ/ENTER** key to select dFL and restore the instrument to the factory default calibration.

Note: *For meters with factory-calibrated ranges or methods, Standard Calibration Adjust (SCA) will be disabled when a user-entered method is programmed into the meter. To turn SCA back on, restore the meter to factory default calibration.*

User-Entered Calibration, continued

Maximum/Minimum Displayed Value

In meters with absorbance (Abs) ranges, the maximum displayed value and minimum displayed value is related to the value of the standards entered in a user calibration.

Measurements that exceed the minimum or maximum standards entered in the user calibration will return a flashing number indicating “underrange” or “overrange”. See *Error Codes* (page 2–10) for more information.

Example 1

For a calibration with the following standards:

S0=0.000

S1=1.000

Maximum Displayed Value	1.000
Minimum Displayed Value	0.000

User-Entered Calibration, continued

Example 2

For a calibration with the following standards:

S0=1.00

S1=2.00

S2=4.00

Maximum Displayed Value	4.00
Minimum Displayed Value	1.00

For Hach-calibrated programs, the maximum and minimum displayed values always equal the factory-calibrated values and cannot be changed.

Certification

Hach Company certifies this instrument was tested thoroughly, inspected, and found to meet its published specifications when it was shipped from the factory.

The Pocket Colorimeter™ II instrument has been tested and is certified as indicated to the following instrumentation standards:

EMC Immunity:

Per 89/ 336/ EEC EMC: EN 61326: 1998 (Electrical Equipment for measurement, control and laboratory use—EMC requirements). Supporting test records by Hach Company, certified compliance by Hach Company.

Standard(s) include:

IEC 1000-4-2: 1995 (EN 61000-4-2: 1995) Electro-Static Discharge Immunity (Criteria B)

IEC 1000- 4- 3: 1995 (EN 61000- 4- 3: 1996) Radiated RF Electro- Magnetic Field Immunity (Criteria A)

Additional Immunity Standard(s) include:

ENV 50204: 1996 Radiated Electromagnetic Field from Digital Telephones

(Criteria A) Radio Frequency Emissions:

Per 89/ 336/ EEC EMC: EN 61326: 1998 (Electrical Equipment for measurement, control and laboratory use—EMC requirements) “Class B” emission limits. Supporting test records from Hach EMC Test Facility, certified compliance by Hach Company.

Additional Radio Frequency Emissions Standard(s) include:

EN 55022 (CISPR 22), Class B emissions limits.

Canadian Interference-causing Equipment Regulation, IECS-003, Class A:

Supporting test records from Hach EMC Test Facility, certified compliance by Hach Company.

This Class A digital apparatus meets all requirements of the Canadian Interference-causing Equipment Regulations.

Cet appareil numérique de la classe A respecte toutes les exigences du Règlement sur le matériel brouilleur du Canada.

FCC Part 15, Class “A” Limits: Supporting test records from Hach EMC Test Facility, certified compliance by Hach Company.

This device complies with Part 15 of the FCC Rules. Operation is subject to the following two conditions:

Certification, continued

(1) This device may not cause harmful interference, and (2) This device must accept any interference received, including interference that may cause undesired operation. Changes or modifications to this unit not expressly approved by the party responsible for compliance could void the user's authority to operate the equipment.

This equipment has been tested and found to comply with the limits for a Class A digital device, pursuant to Part 15 of the FCC Rules. These limits are designed to provide reasonable protection against harmful interference when the equipment is operated in a commercial environment. This equipment generates, uses, and can radiate radio frequency energy and, if not installed and used in accordance with the instruction manual, may cause harmful interference to radio communications. Operation of this equipment in a residential area is likely to cause harmful interference, in which case the user will be required to correct the interference at his own expense. The following techniques of reducing the interference problems are applied easily.

1. Remove power from the Pocket Colorimeter instrument by removing one of its batteries to verify that it is or is not the source of the interference.
2. Move the Pocket Colorimeter instrument away from the device receiving the interference.
3. Reposition the receiving antenna for the device receiving the interference.
4. Try combinations of the above.



GENERAL INFORMATION

At Hach Company, customer service is an important part of every product we make.

With that in mind, we have compiled the following information for your convenience.

How to Order

By Telephone:

6:30 a.m. to 5:00 p.m. MST
Monday through Friday
(800) 227-HACH (800-227-4224)

By FAX:

(970) 669-2932 (Hach Loveland)

Information Required:

- Hach account number (if available)
- Billing address
- Shipping address
- Your name and phone number
- Purchase order number
- Catalog number
- Brief description or model number
- Quantity

By Mail:

Hach Company
P.O. Box 389
Loveland, Colorado 80539-0389 U.S.A.

For order information by E-mail:

orders@www.hach.com

How to Order, continued

Technical and Customer Service (USA only)

Hach Technical and Customer Service Department personnel are eager to answer questions about our products and their use and to take your orders. Specialists in analytical methods, they are happy to put their talents to work for you.

Call 1-800-227-4224 or E-mail techhelp@hach.com.

International Customers

Hach maintains a worldwide network of dealers and distributors. To locate the representative nearest you, send E-mail to intl@hach.com or call (970) 669-3050.

In Canada

Hach Instrument Service Centre, Winnipeg, Manitoba, Canada

Telephone: (204) 632-5589; (800) 665-7635

FAX: (204) 694-5134

Repair Service

Authorization must be obtained from Hach Company before sending any items for repair. Please contact the Hach Service Center serving your location.

In the United States:

Hach Company
100 Dayton Avenue
Ames, Iowa 50010
(800) 227-4224 (USA only)
FAX: (515) 232-3835

Latin America, Caribbean, Africa, Far East, Indian Subcontinent:

Hach Company World Headquarters
P.O. Box 389
Loveland, Colorado 80539-0389 U.S.A.
Telephone: (970) 669-3050
FAX: (970) 669-2932
E-mail: intl@hach.com.

Canada:

Hach Sales & Service Canada Ltd.
1313 Border Street, Unit 34
Winnipeg, Manitoba R3H 0X4
(800) 665-7635 (Canada only)
Telephone: (204) 632-5598
FAX: (204) 694-5134
E-mail: canada@hach.com

Europe, the Middle East, or Mediterranean Africa:

HACH Company, c/o
Dr. Bruno Lange GmbH & CO. KG
Willstätterstr. 11
40549 Düsseldorf, Germany
Telephone: +49/(0)211/52 88-0
FAX: +49/(0)211/52 88-134

Warranty

Hach Company warrants this product to the original purchaser against any defects that are due to faulty material or workmanship for a period of two years from date of shipment.

In the event that a defect is discovered during the warranty period, Hach Company agrees that, at its option, it will repair or replace the defective product or refund the purchase price, excluding original shipping and handling charges. Any product repaired or replaced under this warranty will be warranted only for the remainder of the original product warranty period.

This warranty does not apply to consumable products such as chemical reagents; or consumable components of a product, such as, but not limited to, lamps and tubing.

Contact Hach Company or your distributor to initiate warranty support. Products may not be returned without authorization from Hach Company.

Limitations

This warranty does not cover:

- damage caused by acts of God, natural disaster, labor unrest, acts of war (declared or undeclared), terrorism, civil strife or acts of any governmental jurisdiction
- damage caused by misuse, neglect, accident or improper application or installation
- damage caused by any repair or attempted repair not authorized by Hach Company
- any product not used in accordance with the instructions furnished by Hach Company
- freight charges to return merchandise to Hach Company
- freight charges on expedited or express shipment of warranted parts or product
- travel fees associated with on-site warranty repair

This warranty contains the sole express warranty made by Hach Company in connection with its products. All implied warranties, including without limitation,

Warranty, continued

the warranties of merchantability and fitness for a particular purpose, are expressly disclaimed.

Some states within the United States do not allow the disclaimer of implied warranties and if this is true in your state the above limitation may not apply to you. This warranty gives you specific rights, and you may also have other rights that vary from state to state.

This warranty constitutes the final, complete, and exclusive statement of warranty terms and no person is authorized to make any other warranties or representations on behalf of Hach Company.

Limitation of Remedies

The remedies of repair, replacement or refund of purchase price as stated above are the exclusive remedies for the breach of this warranty. On the basis of strict liability or under any other legal theory, in no event shall Hach Company be liable for any incidental or consequential damages of any kind for breach of warranty or negligence.